

# SmallRig

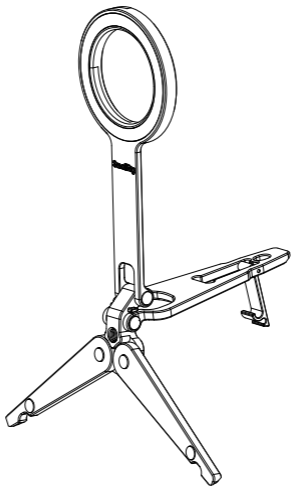

## Mobile Phone Support

手机支撑件

User Manual | 用户手册

- Thank you for purchasing SmallRig's product.  
感谢您购买 SmallRig 产品。
- Please read this User Manual carefully.  
使用本产品之前，请仔细阅读用户手册。
- Please follow the safety warnings.



### Safety Guidelines / 注意事项

- The maximum load capacity of the phone holder : 500g / 17.6oz  
手机夹最大承重500g。
- Sudden or excessive shaking may cause the phone to detach.  
剧烈抖动可能会导致手机脱落。
- External impacts could lead to device detachment.  
外力撞击会导致设备脱落。

### In the Box / 包装清单

Phone Support  
手机支架

× 1

Metal Ring  
引磁环

× 1

## Product Details / 产品介绍

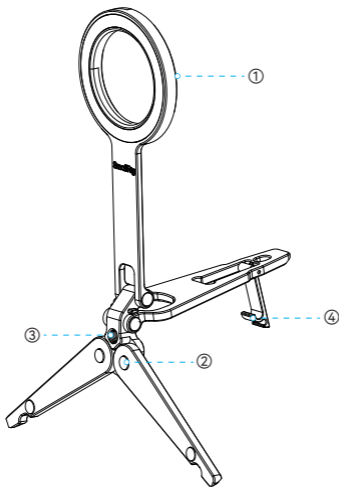

① Metal Ring  
引磁环

② Silicone Pad  
垫片

③ 1/4"-20 Threaded Hole  
1/4"-20 螺纹孔

④ Foldable Hook  
可折叠挂钩

## Installation / 安装步骤

### Step 1 / 步骤一

Selfie Mode / 自拍模式

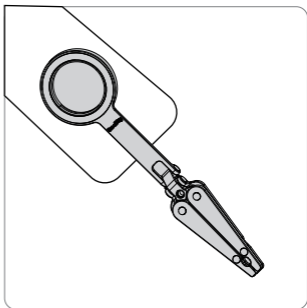

### Step 2 / 步骤二

Desktop Mode / 桌面模式

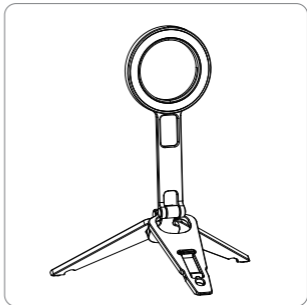

 The package does not include the camera.  
相机机身需另购

### Step 3 / 步骤三

Hook-Mount Mode / 挂钩模式

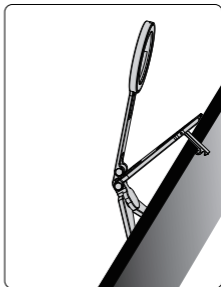

## Specifications / 产品参数

Product Dimensions 产品尺寸	8.9 × 2.3 × 3.8in 226.0 × 59.0 × 95.5mm
Product Weight 产品重量	3.3 ± 0.2oz 93.0 ± 5.0g
Material(s) 主要材质	Aluminum Alloy, Silicone 铝合金、硅胶
Compatibility 兼容性	<ol style="list-style-type: none"><li>1. Compatible with bare (uncased) MagSafe-enabled iPhones.</li><li>2. Supports phones in cases equipped with a MagSafe-compatible magnetic ring.</li></ol> <ol style="list-style-type: none"><li>1. 具有Magsafe功能的手机裸机</li><li>2. 配备磁吸环的带手机壳的手机</li></ol>

 Specifications subject to change without prior notice. Please refer to the physical product for the most up-to-date information.

技术参数如有改动，以实物为准，恕不另行通知。

## Service & Warranty

Please keep your original receipt and guarantee card. Be sure the dealer has written on it the date of purchase and SN of the product. These are required for warranty service.

### **After-sale Warranty Terms:**

SmallRig products are entitled to warranty services as of the date of payment.

- **Electronic products (except V mount battery):** 1-year warranty.
- **V mount battery:** 2-year warranty.
- **Non-electronic products:** 2-year warranty.

**Note:** In case of any conflict between our warranty period policy and applicable laws and regulations of the country / region where the products are sold, the latter shall prevail.

### **This Warranty Does Not Cover:**

- If users fail to adhere to the "Operating Instruction" or any "Warnings" stated in the user manual, resulting in a quality failure, it falls outside the scope of warranty coverage.
- The product identification or SN label is removed or defaced in any way.
- Product damage caused by problems not attributable to the quality of the products such as improper use of the products.
- Product damage caused by unauthorized modification, disassembly, repair and other acts.
- Product damage caused by fires, floods, lightning and other force majeure factors.

### **Warranty Mode:**

- For the products within the scope of warranty, SmallRig will repair or replace them on the basis of specific failures; the repaired / replaced products / parts are entitled to the remaining part of the original warranty period.

### **Contact Information:**

- You're advised to contact the online customer service personnel of corresponding shopping platform and submit a repair service application.
- You may also apply for repair service through SmallRig's service email.

**Service Email:** [support@smallrig.com](mailto:support@smallrig.com)

## 保修条款

请保留您的原始购买单据及保修卡，同时包含您的购买日期、产品序列号等，这些资料质保服务时均需要提供。

### ☰ 售后质保条款：

SmallRig产品自下单付款之日起享有质保服务。

- 电子产品 (除V口电池)：1年质保。
- V口电池：2年质保。
- 非电子产品：2年质保。

注：若销售地国家或地区的适用法律法规有冲突的，以销售地国家或地区有关质保期的法律法规为准。

### ☰ 质保无效说明：

- 当用户违反操作指引或用户手册中“重要提示”任何一条导致的质量失效，不在质保范围内。
- 产品序列号标识已经被撕毁或无法辨识，不在质保范围。
- 产品使用不当等非产品本身质量问题，而造成的产品损坏，不在质保范围。
- 非官方指导的私自改装、拆解、维修等行为而造成的损坏，不在质保范围。
- 因火灾、水灾、雷击等不可抗力造成的产品损坏，不在质保范围。

### ☰ 维修方式：

- 属于质保范围的，SmallRig 根据产品具体的故障对产品进行维修或更换；维修后的产品 / 部件享受原有保修期的剩余时长。

### ☰ 联系方式：

- 建议您优先前往相应购买平台联系在线客服，提出产品维修申请。
- 您也可以通过 SmallRig 服务邮箱申请维修服务。

服务邮箱：[support@smallrig.com](mailto:support@smallrig.com)

## Guarantee Card

ID No.	
Item Name	
Purchase Date	
User Name	
Mobile	
Address	
Receipt	

## 保修卡

ID 编号	
产品名称	
购买日期	
用户姓名	
用户电话	
用户地址	
购买单据	

Manufacturer Email: support@smallrig.com

Manufacturer: Shenzhen Leqi Innovation Co., Ltd.

Addr: Rooms 101, 701, 901, Building 4, Gonglianfuji Innovation Park, No. 58, Ping'an Road, Dafu Community, Guanlan Street, Longhua District, Shenzhen, Guangdong, China.

Consignor: Shenzhen LC Co., Ltd.

Addr: Room 201, Building 4, Gonglianfuji Innovation Park, No. 58, Ping'an Road, Dafu Community, Guanlan Street, Longhua District, Shenzhen, Guangdong, China.

制造商: 深圳市乐其创新股份有限公司

地址: 中国广东省深圳市龙华区观澜街道大富社区平安路58号共联富基创新园4栋101、701、901

委托商: 深圳市乐长科技有限公司

地址: 中国广东省深圳市龙华区观澜街道大富社区平安路58号共联富基创新园4栋201



WE ARE HERE FOR YOU  
服务与支持



ETICHETTATURA AMBIENTALE  
ENVIRONMENTAL LABELING

执行标准: GB/T 26572-2011



GAVIMOSA CONSULTORIA, SOCIEDAD  
LIMITADA, CASTELLANA 9144, 28046 Madrid,  
compliance.gavimosa@outlook.com



Sea&Mew Accounting Ltd,  
Electric Avenue Vision 25, London,  
Enfield EN3 7GD, info@seamew.net

CE RoHS



FR

LE TRI  
+ FACILE



Boîte 1

Papier 5



合格证  
已检验



Séparez les éléments avant de trier

Made in China | 中国制造

FREE YOUR DREAM

自 由 创 想