

SmallRig

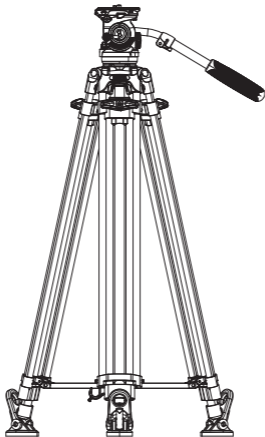

FSD16 FreeSpeed Heavy-Duty Aluminum Alloy Tripod

FSD16 一键开重型铝合金三脚架

User Manual | 用户手册

DE

Bitte lesen Sie diese Produktanleitung, um wichtige Informationen zum Produkt sowie Anweisungen zur Verwendung auf Ihrem Gerät zu erhalten. Diese Anleitung soll Ihnen helfen, das Produkt bequemer, vernünftiger und effizienter zu nutzen.

FR

Veillez lire ce guide produit pour connaître des informations importantes sur le produit et savoir quel appareil est disponible pour vous. Ce guide est conçu pour vous aider à utiliser ce produit de manière plus pratique et plus efficace.

IT

Leggi questa guida al prodotto per ottenere informazioni importanti sul prodotto e su quale dispositivo è disponibile per te. Questa guida è progettata per aiutarti a utilizzare questo prodotto in modo più conveniente, razionale ed efficiente.

ES

Lea esta guía del producto para conocer información importante sobre el producto y el equipo que se aplica a usted. Esta guía está diseñada para ayudarlo a utilizar este producto de manera más conveniente, razonable y eficiente.

NL

Lees deze productgids voor belangrijke informatie over het product en welk apparaat voor u beschikbaar is. Deze handleiding is bedoeld om u te helpen dit product gemakkelijker en efficiënter te gebruiken.

SE

Läs den här produktguiden för att lära dig viktig information om produkten och den utrustning som gäller dig. Den här guiden är utformad för att hjälpa dig att använda den här produkten mer bekvämt, rimligt och effektivt.

BE

Veillez lire ce guide produit pour connaître des informations importantes sur le produit et savoir quel appareil est disponible pour vous. Ce guide est conçu pour vous aider à utiliser ce produit de manière plus pratique et plus efficace.

PL

Proszę przeczytać niniejszy przewodnik produktu, aby uzyskać istotne informacje dotyczące produktu oraz instrukcje dotyczące jego użytkowania na Twoim urządzeniu. Niniejszy przewodnik ma na celu pomóc Ci w bardziej wygodnym, rozsądnym i efektywnym korzystaniu z produktu.

- Thank you for purchasing SmallRig's product.
感谢您购买 SmallRig 产品。
- Please read this User Manual carefully.
使用本产品之前，请仔细阅读用户手册。
- Please follow the safety warnings.
请注意所有警告提示并遵循使用用户手册的所有指令。



Safety Guidelines / 注意事项

- Do not use the product underwater, in extreme temperatures (e.g., freezing or direct heat), corrosive environments, or excessive dust. Dry metal parts immediately after liquid contact to prevent corrosion.
请勿在水下、极端温度（如冷冻或高温暴晒）、强腐蚀性或多尘环境中使用本产品。金属部件接触液体后请立即擦干，避免长期接触水分导致锈蚀。
- Do not exceed the maximum weight capacity indicated on the product. Overloading risks structural failure, deformation, or accidental drops.
请勿超过产品标注的最大承重限制。超载可能导致结构变形、断裂或意外跌落设备。
- Clean surfaces with a dry, soft cloth. Avoid chemicals like alcohol or solvents. Ensure dry and ventilated conditions for long-term storage.
使用干燥软布清洁表面，避免酒精、溶剂等化学试剂直接接触产品。长期存放前请确保环境干燥通风。
- Do not modify the product (e.g., drilling, cutting)—this compromises structural integrity and increases drop risks.
请勿自行对产品进行钻孔、切割或改造，以免破坏结构强度，增加设备跌落风险。
- Stop use immediately if you notice deformation, unusual noises, or loose components, and contact support.
若产品出现变形、异响或部件松动，请立即停止使用并联系客服。

In the Box

Tripod	× 1	Carrying Bag	× 1
Allen Wrench	× 1	Guarantee Card	× 1
Smartphone Holder	× 1		

Product Details

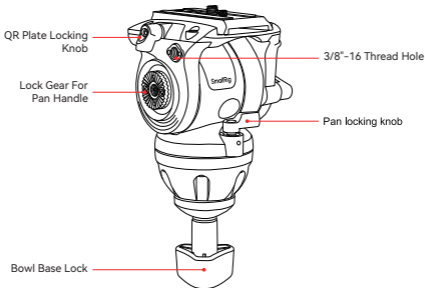
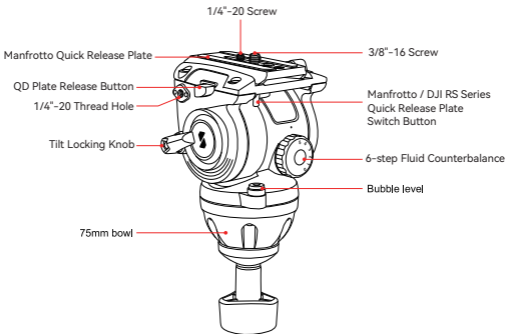

Installation / 安装步骤

Fluid Head Set-up

① Attach the head on the tripod.

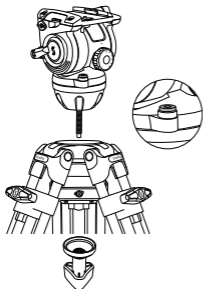

1-1: Please make sure the tripod leg is placed approximately in horizon and tripod leg are locked tightly.

1-2: Place the Head into the tripod bowl, level it using the bubble level.

1-3: Please lock the bowl locking knob tightly.

② Attach the pan handle.

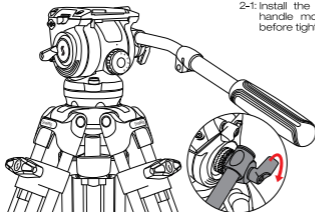

2-1: Install the pan handle on the rosette handle mount and adjust the position before tightening the clamps.

Fluid Head Set-up

④ Attach quick release plate.

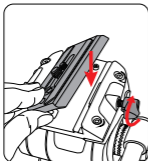

(3-1)

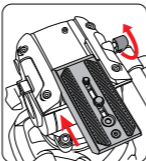

(3-2)

3-1: Please press the plate in until the insurance button is engaged, adjust the plate position then locking it by rotating the button.

3-2: Slide the camera plate forward until the plate insurance button is engaged, then lock the knob.

Pan and Tilt Locks

The pan and tilt locks should be engaged whenever the camera is left unattended.

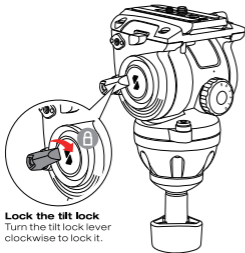

Lock the tilt lock
Turn the tilt lock lever clockwise to lock it.



Lock the pan lock
Turn the pan lock lever clockwise to lock it.

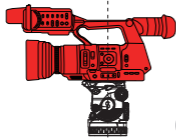

Centre



3: Please hold the camera or pan handle securely in level, then release the tilt locking knob, then observe how the camera moves.

a: If the camera stops in horizon, the balance is achieved.

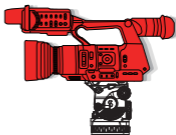
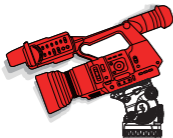

b: If the camera falls forward (lens points downwards), please carefully slide the quick release plate in backwards.

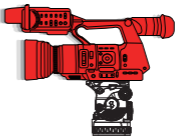

c: If the camera falls backward (lens points upwards), please carefully slide the quick release plate in forwards. (PS: if necessary, please adjust the camera location on the plate).

★ Please repeat the operation until the camera could stay in horizontal position. Then lock the plate locking knob and tilt knob tightly.

Counterbalance Setting

The counterbalance system was designed to neutralise the effect of the camera weight when it is tilted. If the correct counterbalance is achieved, the camera should remain in any tilt position, and it could be moved by minimum effort in tilt.

The camera balance must be set before adjusting the counterbalance.

***Please make sure that camera and all accessories are installed before this operation.**

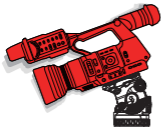

1-1: Hold the camera by securing the pan bar. Turn the counterbalance knob to the number which best compensates for the weights of the camera.

1-2: Releasing the tilt locking knob, tilt the camera upwards or downwards to 45° and release it, pls check if the camera will remain in a fixed tilt position.



a: If moving upwards, please lower the counterbalance. (Anticlockwise)

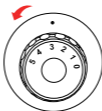

b: If moving downwards, please add the counterbalance. (Clockwise)

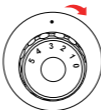
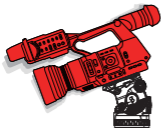

Compatible with Manfrotto and DJI Plates

Rotate to Switch Specifications.

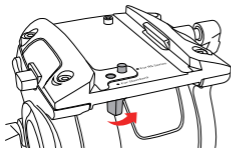

1-1: For RS series

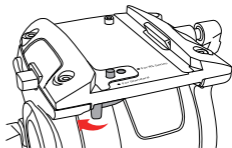

1-2: For Standard

Product Details

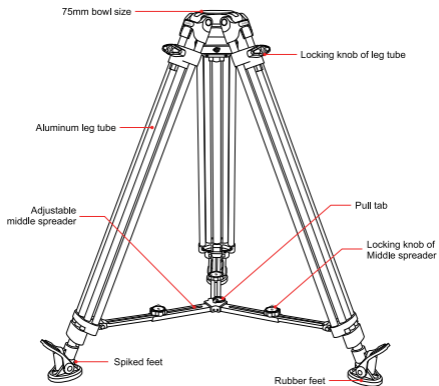

Tripod Using

❶ Height adjustment.

* Please open the tripod and put it on level ground (if possible).

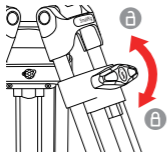

1-1: Loosen the locking knob and lift the tripod to your desired height, then lock it. Repeat the same operation for the other two legs.

1-2: Before mounting the head on, please make sure the tripod is locked tightly.

❷ Middle spreader adjustment.

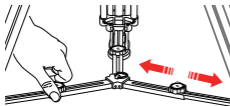

a

a: Length adjustment.

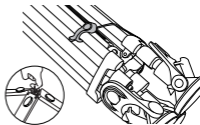

b

b: The transport clips are specially designed to hold the tripod legs together during transport.

❸ Detachable middle spreader

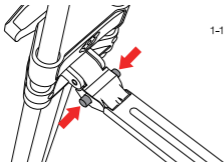

1-1: Press the snap pins to remove the Middle spreader.

Daily Maintenance

Storage and transport:

When not using the head for a long time, please turn all the knobs to the minimum setting.
When not using the tripod, please avoid storing it vertically to prevent damage.
When not using the tripod or during transportation, please ensure it is stored in the carry bag.

Function inspection:

Please check the tripod payload and the condition of the head locking regularly to avoid accidents.
Please regularly check and adjust the condition of the tripod and head locking to increase the service life.

Function inspection:

1. Use a lint-free cloth to clean the tripods regularly.
2. Please store it in the carrying case, if not used for a long time.
3. Use a semi-stiff brush or a vacuum for cleaning.

Always engage safety locks and devices where applicable on the products.

Don't use the product at temperatures below -30°C or above $+60^{\circ}\text{C}$.
Clean with mild detergent and a soft cloth. Remove dust and sand from all locking threads and sliding segments. Dry the product after use in wet conditions.

IMPORTANT: It is not recommended to use the product in seawater.

If you have any questions during the use of the product, please carefully read the instructions or seek help from your local distributor.

Specifications

Product Weight / 产品重量	5.95 ± 0.05kg / 13.1 ± 0.11lb
Working Height / 工作高度	92.5 - 214.0cm / 36.4 to 84.3in
Storage Length / 收纳高度	99.8cm / 39.3in
Leg Diameters / 脚管直径	16.0mm / 16.0mm / 22.0mm
Bowl Diameter / 碗口直径	75.0mm
Tilt Range / 俯/仰角度	90°/-60°
Tilt Damping Levels / 俯仰阻尼档位	/
Pan Damping Levels / 水平阻尼档位	/
Counterbalance Levels / 动平衡档位	6
Counterbalance Load Range / 动平衡承重	0-6.0kg / 0-13.2lb
Max Payload / 最大承重	15.0kg / 33.1lb
Safe Load Capacity / 安全承重	10.0kg / 22.0lb

 Specifications subject to change without prior notice. Please refer to the physical product for the most up-to-date information.

技术参数如有改动，以实物为准，恕不另行通知。

Service & Warranty

Please keep your original receipt and guarantee card. Be sure the dealer has written on it the date of purchase and SN of the product. These are required for warranty service.

After-sale Warranty Terms:

SmallRig products are entitled to warranty services as of the date of payment.

- **Electronic products (except V mount battery):** 1-year warranty.
- **V mount battery:** 2-year warranty.
- **Non-electronic products:** 2-year warranty.

Note: In case of any conflict between our warranty period policy and applicable laws and regulations of the country / region where the products are sold, the latter shall prevail.

This Warranty Does Not Cover:

- If users fail to adhere to the "Operating Instruction" or any "Warnings" stated in the user manual, resulting in a quality failure, it falls outside the scope of warranty coverage.
- The product identification or SN label is removed or defaced in any way.
- Product damage caused by problems not attributable to the quality of the products such as improper use of the products.
- Product damage caused by unauthorized modification, disassembly, repair and other acts.
- Product damage caused by fires, floods, lightning and other force majeure factors.

Warranty Mode:

- For the products within the scope of warranty, SmallRig will repair or replace them on the basis of specific failures; the repaired / replaced products / parts are entitled to the remaining part of the original warranty period.

Contact Information:

- You're advised to contact the online customer service personnel of corresponding shopping platform and submit a repair service application.
- You may also apply for repair service through SmallRig's service email.

Service Email: support@smallrig.com

保修条款

请保留您的原始购买单据及保修卡，同时包含您的购买日期、产品序列号等，这些资料质保服务时均需要提供。

售后质保条款：

SmallRig产品自下单付款之日起享有质保服务。

- 电子产品 (除V口电池)：1年质保。
- V口电池：2年质保。
- 非电子产品：2年质保。

注：若销售地国家或地区的适用法律法规有冲突的，以销售地国家或地区有关质保期的法律法规为准。

质保无效说明：

- 当用户违反操作指引或用户手册中“重要提示”任何一条导致的质量失效，不在质保范围内。
- 产品序列号标识已经被撕毁或无法辨识，不在质保范围。
- 产品使用不当等非产品本身质量问题，而造成的产品损坏，不在质保范围。
- 非官方指导的私自改装、拆解、维修等行为而造成的损坏，不在质保范围。
- 因火灾、水灾、雷击等不可抗力造成的产品损坏，不在质保范围。

维修方式：

- 属于质保范围的，SmallRig 根据产品具体的故障对产品进行维修或更换；维修后的产品 / 部件享受原有保修期的剩余时长。

联系方式：

- 建议您优先进往相应购买平台联系在线客服，提出产品维修申请。
- 您也可以通过 SmallRig 服务邮箱申请维修服务。

服务邮箱：support@smallrig.com

Guarantee Card

ID No.	
Item Name	
Purchase Date	
User Name	
Mobile	
Address	
Receipt	

保修卡

ID 编号	
产品名称	
购买日期	
用户姓名	
用户电话	
用户地址	
购买单据	

Manufacturer Email: support@smallrig.com

Manufacturer: Shenzhen Leqi Innovation Co., Ltd.

Add: Rooms 101, 701, 901, Building 4, Gonglianfuji Innovation Park, No. 58, Ping'an Road, Dafu Community, Guanlan Street, Longhua District, Shenzhen, Guangdong, China.

Consignor: Shenzhen LC Co., Ltd.

Add: Room 201, Building 4, Gonglianfuji Innovation Park, No. 58, Ping'an Road, Dafu Community, Guanlan Street, Longhua District, Shenzhen, Guangdong, China.

制造商: 深圳市乐其创新股份有限公司

地址: 中国广东省深圳市龙华区观澜街道大富社区平安路58号共联富基创新园4栋101、701、901

委托商: 深圳市乐长科技有限公司

地址: 中国广东省深圳市龙华区观澜街道大富社区平安路58号共联富基创新园4栋201



WE ARE HERE FOR YOU
服务与支持



ETICHETTATURA AMBIENTALE
ENVIRONMENTAL LABELING

执行标准: GB 4943.1-2022、GB/T 26572-2011

Made in China | 中国制造

EC REP GAVIMOSA CONSULTORIA, SOCIEDAD LIMITADA, CASTELLANA 9144, 28046 Madrid, compliance.gavimosa@outlook.com

UK REP Sea&Mew Accounting Ltd, Electric Avenue Vision 25, London, Enfield EN3 7GD, info@seamew.net

CE RoHS



合格证
已检验



FR
LE TRI
+ FACILE



Boîte 12



Cale 1



Papier 5



Sachet 3



RECICLA
Al Azul

Séparez les éléments avant de trier

FREE YOUR DREAM

自 由 创 想