

SmallRig

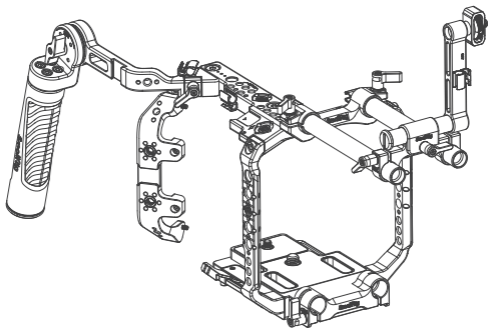

Cage Kit for FUJIFILM GFX ETERNA 55

拓展框套件 (适用于富士 GFX ETERNA 55)



Safety Guidelines / 注意事项

- Do not use the product underwater, in extreme temperatures (e.g., freezing or direct heat), corrosive environments, or excessive dust. Dry metal parts immediately after liquid contact to prevent corrosion.

请勿在水下、极端温度（如冷冻或高温暴晒）、强腐蚀性或多尘环境中使用本产品。金属部件接触液体后请立即擦干，避免长期接触水分导致锈蚀。

- Do not exceed the maximum weight capacity indicated on the product. Overloading risks structural failure, deformation, or accidental drops.

请勿超过产品标注的最大承重限制。超载可能导致结构变形、断裂或意外跌落设备。

- Clean surfaces with a dry, soft cloth. Avoid chemicals like alcohol or solvents. Ensure dry and ventilated conditions for long-term storage.

使用干燥软布清洁表面，避免酒精、溶剂等化学试剂直接接触产品。长期存放前请确保环境干燥通风。

- Do not modify the product (e.g., drilling, cutting)—this compromises structural integrity and increases drop risks.

请勿自行对产品进行钻孔、切割或改造，以免破坏结构强度，增加设备跌落风险。

- Stop use immediately if you notice deformation, unusual noises, or loose components, and contact support.

若产品出现变形、异响或部件松动，请立即停止使用并联系客服。

In the Box / 包装清单

Top Plate (with 15mm Dual Rod Clamp) 15mm 双管顶板	× 1	15mm Dual Rod Base Plate 15mm 双管底座	× 1
Left Side Plate 左侧板	× 1	15mm Rod (15cm) 15mm 管 (15cm)	× 2
Right Side Plate 右侧板	× 1	Rear Side Plate 后侧板	× 1
Control Handle 控制手柄	× 1	Monitor Mount 监视器支架	× 1
M3 Screw M3 螺丝	× 4	Allen Wrench 六角扳手	× 1
User Manual 用户手册	× 1		

Product Details / 产品介绍

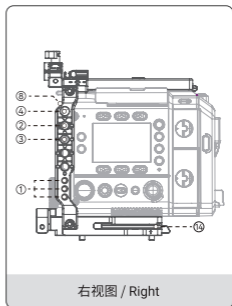
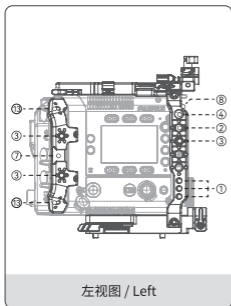
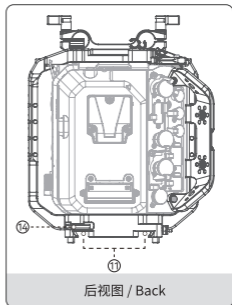
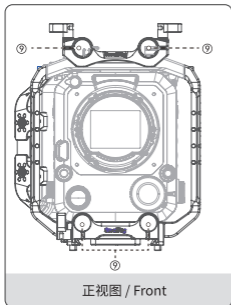

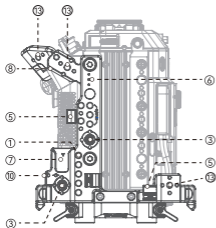

顶视图 / Top

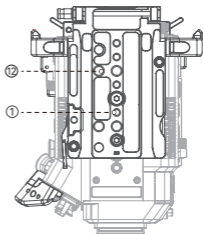



底视图 / Bottom

- | | | |
|--|-----------------------------------|---|
| ① 1/4"-20 Threaded Hole
1/4"-20 螺纹孔 | ⑥ Cable Clamp Hole
线夹孔 | ⑪ ARRI Standard Dovetail Spec.
阿莱标准燕尾槽规格 |
| ② 3/8"-16 ARRI Locating Hole
阿莱定位孔 | ⑦ Cold Shoe Mount
冷靴座 | ⑫ 3/8"-16 Threaded Hole
3/8"-16 螺纹孔 |
| ③ 3/8"-16 to 1/4"-20 Adapter
3/8"-16 转 1/4"-20 螺牙 | ⑧ NATO Rail
滑条 | ⑬ 1/4"-20 Locating Hole
1/4"-20 定位孔 |
| ④ QD Socket
QD 接口 | ⑨ 15mm Dual Rod Clamp
15mm 双管夹 | ⑭ Allen Wrench
六角扳手 |
| ⑤ Cable Clamp
线夹 | ⑩ Measure Hook Hole
卷尺挂钩孔 | |

Top Plate / Baseplate / Side Plate Installation

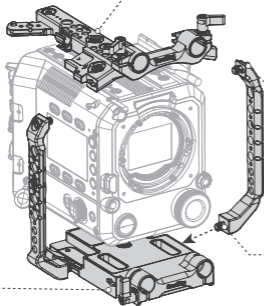
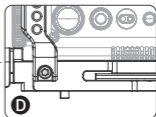
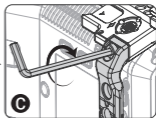
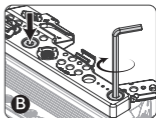
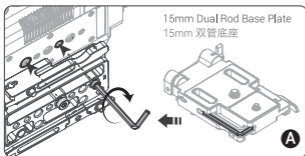
顶板 / 底板 / 侧板安装步骤



 Please install in the following order: baseplate, top plate, side plates.
请按照底板、顶板、侧板的顺序安装。

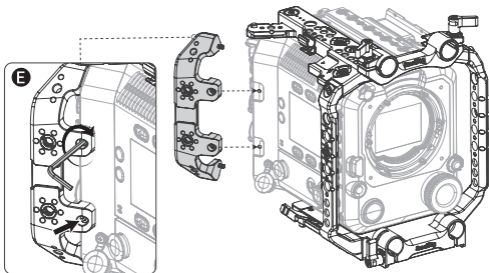

Control Handle Installation / 控制手柄安装步骤

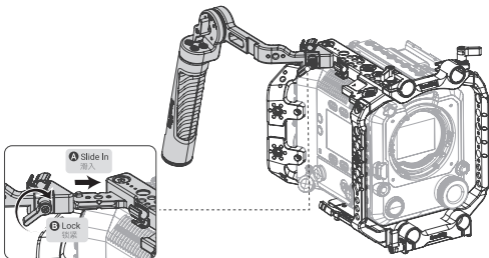

 The package does not include the camera, top handle, monitor ARRI Standard Dovetail Plate.

相机机身，原厂上手提，监视器和阿莱燕尾槽板需另购。

15mm Dual Rod Clamp Installation / 15mm 双管安装步骤

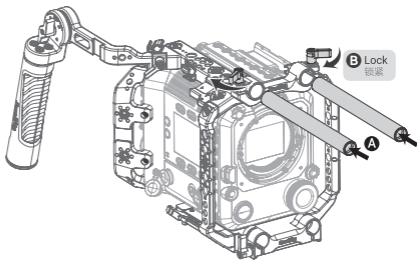

Monitor Mount Installation / 监视器支架安装步骤

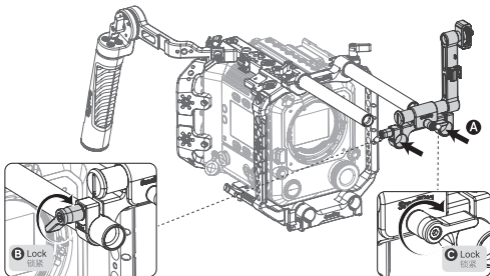

 **Note:** The knob can adjust two clamps simultaneously.
注意: 单个旋钮可同时调节两个管夹。

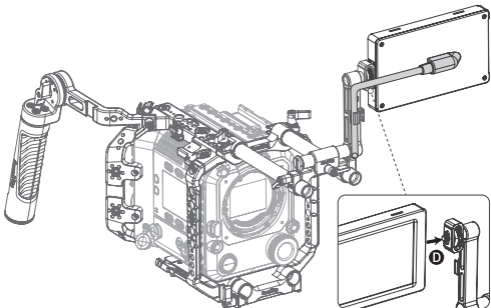

Specifications / 产品参数

Product Dimensions 产品尺寸	11.6 × 8.4 × 11.8in 296.0 × 212.5 × 300.0mm
Product Weight 产品重量	43.9 ± 0.5oz 1244.7 ± 10.0g
Material(s) 主要材质	Aluminum Alloy 铝合金
Compatibility 兼容性	FUJIFILM GFX ETERNA 55 富士 GFX ETERNA 55

 Specifications subject to change without prior notice. Please refer to the physical product for the most up-to-date information.

技术参数如有改动，以实物为准，恕不另行通知。

Service & Warranty

Please keep your original receipt and guarantee card. Be sure the dealer has written on it the date of purchase and SN of the product. These are required for warranty service.

After-sale Warranty Terms:

SmallRig products are entitled to warranty services as of the date of payment.

- **Electronic products (except V mount battery):** 1-year warranty.
- **V mount battery:** 2-year warranty.
- **Non-electronic products:** 2-year warranty.

Note: In case of any conflict between our warranty period policy and applicable laws and regulations of the country / region where the products are sold, the latter shall prevail.

This Warranty Does Not Cover:

- If users fail to adhere to the "User Manual" or any "Warnings" stated in the user manual, resulting in a quality failure, it falls outside the scope of warranty coverage.
- The product identification or SN label is removed or defaced in any way.
- Product damage caused by problems not attributable to the quality of the products such as improper use of the products.
- Product damage caused by unauthorized modification, disassembly, repair and other acts.
- Product damage caused by fires, floods, lightning and other force majeure factors.

Warranty Mode:

- For the products within the scope of warranty, SmallRig will repair or replace them on the basis of specific failures; the repaired / replaced products / parts are entitled to the remaining part of the original warranty period.

Contact Information:

- You're advised to contact the online customer service personnel of corresponding shopping platform and submit a repair service application.
- You may also apply for repair service through SmallRig's service email.

Service Email: support@smallrig.com

保修条款

请保留您的原始购买单据及保修卡，同时包含您的购买日期、产品序列号等，这些资料质保服务时均需要提供。

☰ 售后质保条款：

SmallRig产品自下单付款之日起享有质保服务。

- 电子产品 (除V口电池)：1年质保。
- V口电池：2年质保。
- 非电子产品：2年质保。

注：若销售地国家或地区的适用法律法规有冲突的，以销售地国家或地区有关质保期的法律法规为准。

☰ 质保无效说明：

- 当用户违反用户手册或用户手册中“重要提示”任何一条导致的质量失效，不在质保范围内。
- 产品序列号标识已经被撕毁或无法辨识，不在质保范围。
- 产品使用不当等非产品本身质量问题，而造成的产品损坏，不在质保范围。
- 非官方指导的私自改装、拆解、维修等行为而造成的损坏，不在质保范围。
- 因火灾、水灾、雷击等不可抗力造成的产品损坏，不在质保范围。

☰ 维修方式：

- 属于质保范围的，SmallRig 根据产品具体的故障对产品进行维修或更换；维修后的产品 / 部件享受原有保修期的剩余时长。

☰ 联系方式：

- 建议您优先前往相应购买平台联系在线客服，提出产品维修申请。
- 您也可以通过 SmallRig 服务邮箱申请维修服务。

服务邮箱：support@smallrig.com

Guarantee Card

ID No.	
Item Name	
Purchase Date	
User Name	
Mobile	
Address	
Receipt	

保修卡

ID 编号	
产品名称	
购买日期	
用户姓名	
用户电话	
用户地址	
购买单据	

Manufacturer Email: support@smallrig.com

Manufacturer: Shenzhen Leqi Innovation Co., Ltd.

Address: Rooms 101, 701, 901, Building 4, Gonglianfuji Innovation Park, No. 58, Ping'an Road, Dafu Community, Guanlan Street, Longhua District, Shenzhen, Guangdong, China.

Consignor: Shenzhen LC Co., Ltd.

Address: Room 201, Building 4, Gonglianfuji Innovation Park, No. 58, Ping'an Road, Dafu Community, Guanlan Street, Longhua District, Shenzhen, Guangdong, China.

制造商: 深圳市乐其创新股份有限公司

地址: 中国广东省深圳市龙华区观澜街道大富社区平安路58号共联富基创新园4栋101、701、901

委托商: 深圳市乐长科技有限公司

地址: 中国广东省深圳市龙华区观澜街道大富社区平安路58号共联富基创新园4栋201



WE ARE HERE FOR YOU
服务与支持



ETICHETTATURA AMBIENTALE
ENVIRONMENTAL LABELING

执行标准: GB/T 26572-2011

LQ-P1646-18



GAVIMOSA CONSULTORIA, SOCIEDAD
LIMITADA, CASTELLANA 9144, 28046 Madrid,
compliance.gavimosa@outlook.com



Sea&Mew Accounting Ltd,
Electric Avenue Vision 25, London,
Enfield EN3 7GD, info@seamew.net

CE RoHS



FR
LE TRI
+ FACILE



Boîte 1 Papier 5



合格证
已检验



Séparez les éléments avant de trier Made in China | 中国制造